



### INDEX

---

PPS Nuts for 1/4"-28 Flat Bottom Fitting Details	59
PEEK Flangeless Nuts	62
Polyacetal Color Coded Flangeless Nuts	63
Polypropylene Flanged Fingertight Nuts	64
Unions	65
Bulkhead Unions	67
PEEK Tees, Crosses and Manifolds Low Pressure	68
PEEK Biocompatible Mixing Tees – Low Pressure	70
Micro Valves for GC and LC	71
Peristaltic Tubing Adapter Set	72
Low-Pressure Polypropylene Adapters	73

#### Disclaimer

The maximum holding pressure for any type of connection involving tubing and a ferrule, varies considerably with the tubing material, the ferrule material, the clearance between tubing OD and ferrule ID and the shape of the fitting detail.

PPS Nuts for 1/4"-28 Flat Bottom Fitting Details

Specs

Material

Nuts: PPS – PolyPhenylene Sulphide, black  
Collapsible ferrules: CTFE  
Inverted ferrules: ETFE  
Washers: polypropylene  
Sleeves: polypropylene

Chemical Resistance of PPS

Chemical Class	Resistance
Acids, organic	A
Acids, inorganic	B/C*
Aldehydes	A
Alcohols	A
Bases	B
Esters	A
Halogenated Org.	A/B
Hydrocarbons	A
Ketones	A

\*conc. Halogen Acids  
A = suitable  
B = marginal – dependant on application  
C = not recommended

Detailed chemical resistance chart see page 118, ff

Dimensions

For 1/16" and 1/8" OD tubing  
Others: see illustration

Threads

1/4"-28

Pressure Rating

collapsible ferrule:  
1/16" up to 105 bar (1500 psi)

1/8" up to 35 bar (500 psi)

Ferrule/bushing 1/16":  
480 bar (7000 psi)

Ferrule/bushing 1/32":  
175 bar (2500 psi)

Varies with tubing material and ID

Tech Tip

For flanging tubing we recommend the VICI Jour Easy Flange Kit (see page 32-33)

PPS Nuts for 1/4"-28 Flat Bottom Fitting Details

- Economically priced alternative to PEEK
- Excellent chemical resistance
- Fits 1/16" or 1/8" OD tubing
- Slim design – fingertight with adapter

The VICI Jour PPS 1/4"-28 fitting series offers excellent chemical and pressure resistance. There is a choice of three different sealing options:

collapsible ferrule, inverted ferrule or flanged with washer.

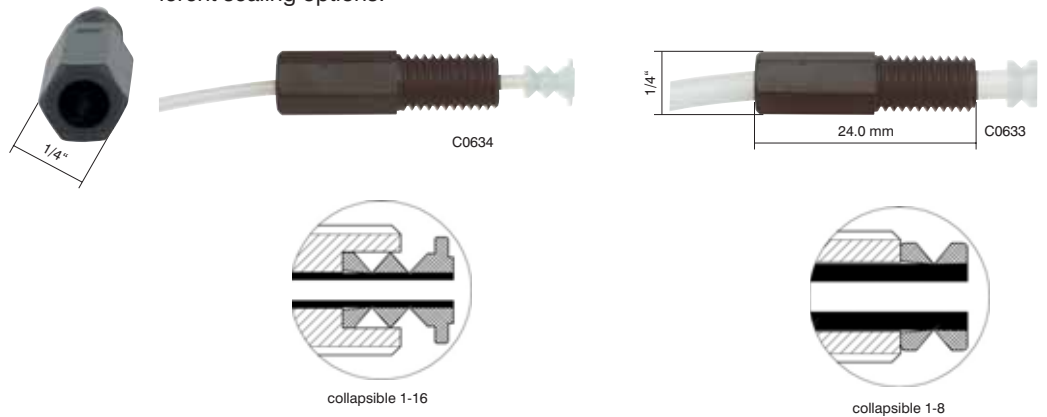

Flangeless type: Collapsible ferrule\* connection

Very effective sealing on narrow areas without distortion of the tubing. No flanging tools required.

Part No.	Description	Qty/pkg
JR-55050-10	Nut, PPS, for collapsible ferrule 1/16", 1/4"-28	10
JR-55051-10	Nut, PPS, for collapsible ferrule 1/8", 1/4"-28	10
JR-CFL-CB1KF	Ferrule, CTFE, collapsible, 1/16"	10
JR-CFL-CB2KF	Ferrule, CTFE, collapsible, 1/8"	10

\*collapsible ferrule (see glossary): Patent No. 6,575,501



Use the PEEK ferrule and bushing as follows:  
First place the nut on the tubing, than the bushing, than the PEEK ferrule.

Flangeless type: ferrule and bushing

With the PEEK ferrule and the SS bushing you get a high pressure connection in a 1/4"-28 port. Should be used with Nut JR-55050.

Part No.	Description	Qty/pkg
JR-55050-10	Nut, PPS, for collapsible ferrule 1/16", 1/4"-28	10
JR-FPKBSS.5	Bushing, SS and ferrule, PEEK, package 1/32"	10
JR-FPKBSS1	Bushing, SS and ferrule, PEEK, package 1/16"	10

For Color-Sleeve fingertight adapters see page 61.

## PPS Nuts for 1/4"-28 Flat Bottom Fitting Details

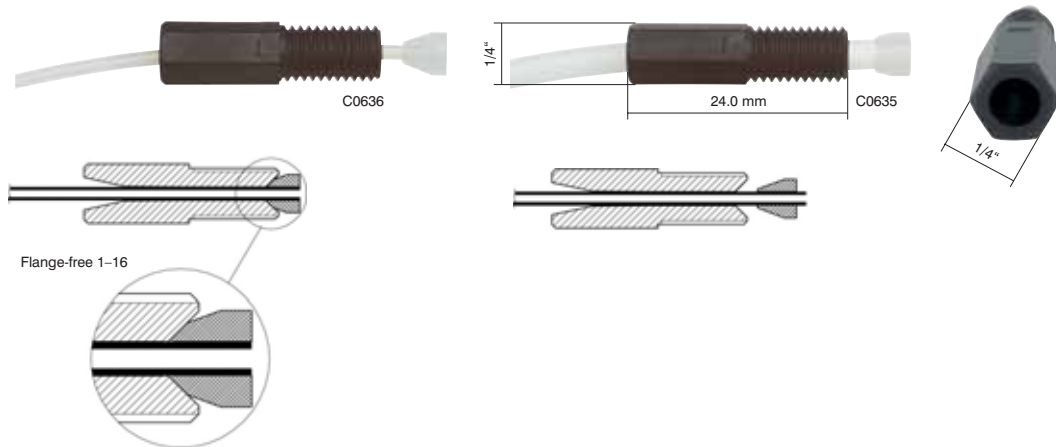

### Flangeless type: Inverted ferrule connection

No flanging tools required.

Part No.	Description	Qty/pkg
JR-55070-10	Nut, PPS, flangeless 1/16", 1/4"-28	10
JR-55071-10	Nut, PPS, flangeless 1/8", 1/4"-28	10
JR-041-10	Ferrule, ETFE, 1/16"	10
JR-051-10	Ferrule, ETFE, 1/8"	10

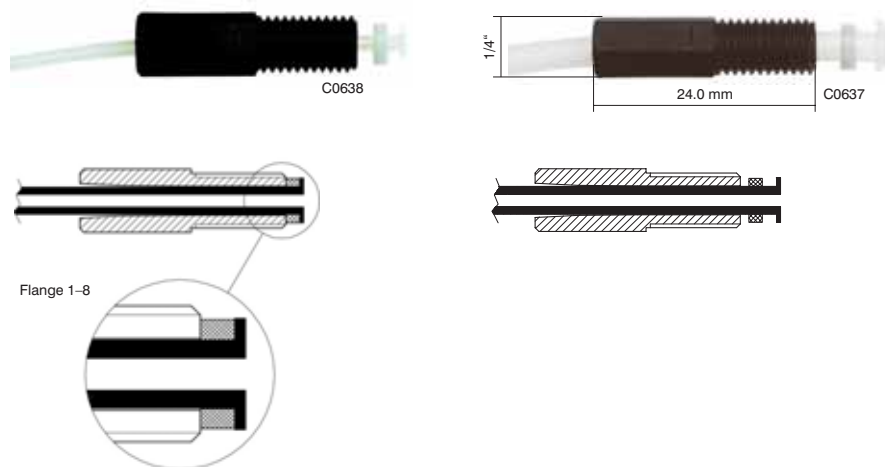

### Flanged type: Flange/washer connection

Solvent comes into contact only with the tubing.

Part No.	Description	Qty/pkg
JR-55060-10	Nut, PPS, flanged 1/16", 1/4"-28	10
JR-55061-10	Nut, PPS, flanged 1/8", 1/4"-28	10
JR-201926-10	Washer, PP, flanged, 1/16"	10
JR-201928-10	Washer, PP, flanged, 1/8"	10

### Specs

#### Material

Nuts: PPS – PolyPhenylene Sulphide, black  
Collapsible ferrules: CTFE  
Inverted ferrules: ETFE  
Washers: polypropylene  
Sleeves: polypropylene

#### Chemical Resistance of PPS

Chemical Class	Resistance
Acids, organic	A
Acids, inorganic	B/C*
Aldehydes	A
Alcohols	A
Bases	B
Esters	A
Halogenated Org.	A/B
Hydrocarbons	A
Ketones	A

\*conc. Halogen Acids

A = suitable

B = marginal – dependant on application

C = not recommended

Detailed chemical resistance chart see page 118, ff

#### Dimensions

For 1/16" and 1/8" OD tubing

Others: see illustration

#### Threads

1/4"-28

#### Pressure Rating

1/16" up to 105 bar (1500 psi)

1/8" up to 35 bar (500 psi)  
Varies with tubing material and ID

#### Tech Tip

For flanging tubing we recommend the VICI Jour Easy Flange Kit (see page 32–33)

PPS Nuts for 1/4”-28 Flat Bottom Fitting Details

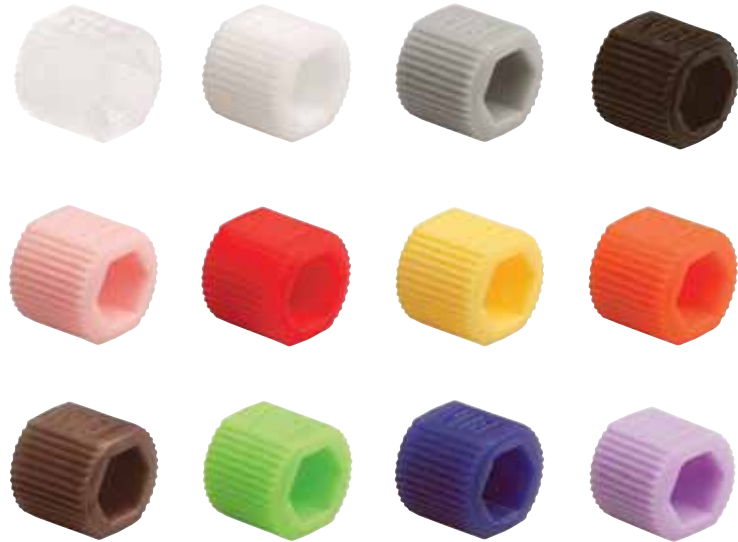

**Color-Sleeve – fingertight adapter**

This sleeve is useful to color code different solvent lines and it turns the new VICI Jour low pressure nut into a fingertight fitting in an instant. The Color-Sleeve is available in 12 colors.

Part No.	Description	Qty/pkg
JR-55080-10	Adapter, PP, fingertight sleeve, natural	10
JR-55081-10	Adapter, PP, fingertight sleeve, white	10
JR-55082-10	Adapter, PP, fingertight sleeve, dark grey	10
JR-55083-10	Adapter, PP, fingertight sleeve, black	10
JR-55084-10	Adapter, PP, fingertight sleeve, lavender	10
JR-55085-10	Adapter, PP, fingertight sleeve, red	10
JR-55086-10	Adapter, PP, fingertight sleeve, yellow	10
JR-55087-10	Adapter, PP, fingertight sleeve, orange	10
JR-55088-10	Adapter, PP, fingertight sleeve, brown	10
JR-55089-10	Adapter, PP, fingertight sleeve, green	10
JR-55090-10	Adapter, PP, fingertight sleeve, blue	10
JR-55091-10	Adapter, PP, fingertight sleeve, purple	10
JR-5508X-24	Adapter, PP, fingertight sleeve, assorted 2 pcs. per color	24
JR-5508X-12	Adapter, PP, fingertight sleeve, assorted 2 pcs. each blue, red, green, yellow, black, white	12

## PEEK Flangeless Nuts

### PEEK Flangeless Nuts

- Flange-free
- Compatible with all 1/4"-28 flat bottom ports
- Excellent chemical resistance
- Fits 1/16" or 1/8" OD tubing
- True fingertight – no tools required

PEEK Flangeless Nuts in combination with the inverted ferrule do not require flanging tools. A hand tightening procedure makes leak free seals. The inert

ETFE ferrule is the only part, besides the tubing, which is in contact with the fluid – the nut is never in contact with the fluid stream (see illustration).



### PEEK Flangeless Nuts

Part No.	Description	Qty/pkg
JR-20124-10	Nut, PEEK, flangeless, natural, 1/16"	10
JR-20116-10	Nut, PEEK, flangeless, natural, 1/8"	10
JR-041-10	Ferrule, ETFE, 1/16"	10
JR-051-10	Ferrule, ETFE, 1/8"	10

### SPECS

**Material**  
Nuts: PEEK  
Ferrules: ETFE

**Dimensions**  
For 1/16" and 1/8" OD tubing  
Others: see illustration

**Threads:**  
1/4"-28

**Pressure rating**  
1/16" up to 105 bar (1500 psi)  
1/8" up to 35 bar (500 psi)  
Varies with tubing material and ID

Polyacetal Color Coded Flangeless Nuts

SPECS

Material

Nuts: Polyacetal  
Ferrules: ETFE

Dimensions

For 1/16" and 1/8" OD tubing  
Others: see illustration

Threads

1/4"-28

Pressure rating

1/16" up to 70 bar (1000 psi)  
1/8" up to 35 bar (500 psi)  
Varies with tubing material and ID

Note

Flangeless fittings for 1/4" OD tubing available: see spare parts for unions on page 66

Polyacetal Color Coded Flangeless Nuts

- Value for money alternative to PEEK
- Flange-free – compatible with all 1/4"-28 flat bottom ports
- Fits 1/16" or 1/8" OD tubing
- True fingertight – no tools required

Polyacetal Flangeless Nuts in combination with the inverted ferrule do not require flanging tools. A hand tightening procedure makes leak free seals. The inert ETFE ferrule is the only part, besides

the tubing, which is in contact with the fluid – the nut is never in contact with the fluid stream (see illustration) Six colors are available.



Flange-free 1-16

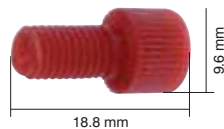
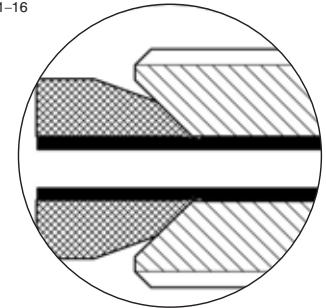

Polyacetal Color Coded Flangeless fingertight Nuts 1/16"

Part No.	Description	Color	Qty/pkg
JR-040GR-10	Nut, Polyacetal, flangeless	green	10
JR-040BL-10	Nut, Polyacetal, flangeless	blue	10
JR-040YL-10	Nut, Polyacetal, flangeless	yellow	10
JR-040RE-10	Nut, Polyacetal, flangeless	red	10
JR-040WH-10	Nut, Polyacetal, flangeless	white	10
JR-040BK-10	Nut, Polyacetal, flangeless	black	10
JR-040WL-10	Nut, Polyacetal, flangeless, 1" long	white	10
JR-041-10	Ferrule, ETFE, 1/16"		10

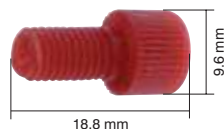

Polyacetal Color Coded Flangeless fingertight Nuts 1/8"

Part No.	Description	Color	Qty/pkg
JR-050GR-10	Nut, Polyacetal, flangeless	green	10
JR-050BL-10	Nut, Polyacetal, flangeless	blue	10
JR-050YL-10	Nut, Polyacetal, flangeless	yellow	10
JR-050RE-10	Nut, Polyacetal, flangeless	red	10
JR-050WH-10	Nut, Polyacetal, flangeless	white	10
JR-050BK-10	Nut, Polyacetal, flangeless	black	10
JR-050WL-10	Nut, Polyacetal, flangeless, 1" long	white	10
JR-051-10	Ferrule, ETFE, 1/8"		10

## Polypropylene Flanged Fingertight Nuts

### Polypropylene Flanged Fingertight Nuts

- For flanged connections
- Compatible to all 1/4"-28 flat bottom ports
- For 1/16" or 1/8" OD tubing
- Fiber glass reinforced PP with PP washers

A number of chromatography systems still require or prefer flanged connections. Consequently, we offer a series of such nuts. By flanging the tubing, the washer never comes in contact with the mobile phase.

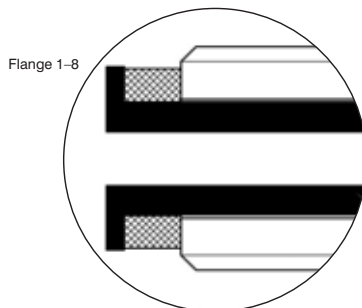

### SPECS

#### Material

Nuts: fiberglass reinforced polypropylene  
Washers: polypropylene

#### Dimensions

For OD 1/16", 1/8" tubing  
Others: see illustration

#### Threads

1/4"-28

#### Pressure rating

< 30 bar (435 psi)  
Varies with tubing material and ID

#### Tech Tip

We recommend our Easy Flange Kit for flanging tubing (see page 32-33)



### Flanged Fingertight Nuts 1/16"

Part No.	Description	Color	Qty/pkg
JR-201094BK-10	Nut, PP, flanged	black	10
JR-201094WH-10	Nut, PP, flanged	white	10
JR-202118-10	Nut, PP, flanged x-long 1"	black	10
JR-202120-10	Nut, PP, flanged x-long 1"	white	10
JR-202122-10	Nut, PP, flanged	blue	10
JR-202123-10	Nut, PP, flanged	green	10
JR-202124-10	Nut, PP, flanged	yellow	10
JR-202125-10	Nut, PP, flanged	red	10
JR-201926-10	Washer, PP, flanged 1/16"		10

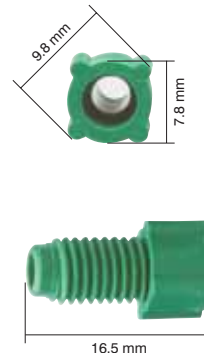

### Flanged Fingertight Nuts 1/8"

Part No.	Description	Color	Qty/pkg
JR-201580BK-10	Nut, PP, flanged	black	10
JR-201580WH-10	Nut, PP, flanged	white	10
JR-202119-10	Nut, PP, flanged x-long	white	10
JR-202121-10	Nut, PP, flanged x-long	black	10
JR-202142-10	Nut, PP, flanged	blue	10
JR-202143-10	Nut, PP, flanged	green	10
JR-202144-10	Nut, PP, flanged	yellow	10
JR-202145-10	Nut, PP, flanged	red	10
JR-201928-10	Washer, PP, flanged 1/8"		10

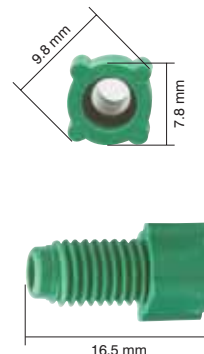

**SPECS**

**Materials**

Unions: PEEK, polyamide  
Nuts: PPS  
Ferrules: ETFE, CTFE  
Sleeves: polypropylene

**Dimensions**

See illustrations

**Threads**

Unions: 1/4"-28  
reducing Union:  
1/2"-20 to 1/4"-28

**Pressure rating**

of PEEK unions  
1/16" up to 105 bar  
(1500 psi)  
1/8" up to 35 bar (500 psi)  
Varies with tubing material  
and ID

**Note**

Complete versions are  
supplied with PPS flange-  
less nuts and ETFE fer-  
rules for 1/16" OD tubing  
(see page 60)

**Tech Tip**

VICI Unions have 1/4"-28  
flat bottom ports

All of our three different  
sealing options (collapsi-  
ble ferrule, inverted ferrule  
or flanged with washer)  
can be used (see pages  
59–64)

To avoid diffusion of gases  
in your solvent line use our  
Impermeable tubing on  
page 27

**Unions**

- For easy connection of low pressure solvent lines
- Low dead volume
- Completely inert and biocompatible

These unions allow the connection of two  
pieces of 1/16", 1/8" or 1/8" to 1/4" OD  
tubing quickly and reliably. The unions  
are inert and biocompatible.

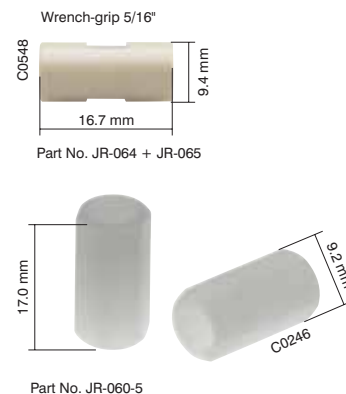

**Union polyamide**

Part No.	Description	Qty/pkg
JR-060-5	Union, polyamide, through bore LP body only, 1/4"-28, for flanged tubing only	5

For nuts and washers see page 60 and 64.

**Unions PEEK**

Part No.	Description	Qty/pkg
JR-1064	Union, PEEK, LP 0.5 mm bore, complete, 1/16" tubing	1
JR-1068	Union, PEEK, LP 0.75 mm bore, complete, 1/16" tubing	1
JR-1065	Union, PEEK, LP 1.3 mm bore, complete, 1/8" tubing	1
JR-064	Union, PEEK, LP 0.5 mm bore, body only	1
JR-068	Union, PEEK, LP 0.75 mm bore, body only	1
JR-065	Union, PEEK, LP 1.3 mm bore, body only	1

**Spare Parts**

Part No.	Description	Qty/pkg
JR-55070-10	Nut, PPS, flangeless, 1/16", 1/4"-28, black	10
JR-55071-10	Nut, PPS, flangeless, 1/8", 1/4"-28, black	10
JR-041-10	Ferrule, ETFE, 1/16"	10
JR-051-10	Ferrule, ETFE, 1/8"	10
JR-55086-10	Adapter, PP, fingertight sleeve, yellow	10
JR-55090-10	Adapter, PP, fingertight sleeve, blue	10

Adapters available in different colors (see page 61).

## Unions

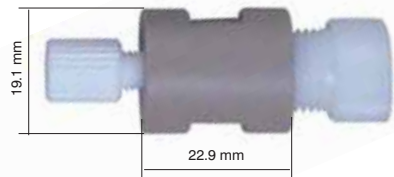

### reducing Union

Part No.	Description	Qty/pkg
JR-CU4LPK	reducing Union, PEEK, LP 1.5 mm bore, 1/4" to 1/8" complete	1

### Spare Parts

Part No.	Description	Qty/pkg
JR-CFL-4D	Nut, polyacetal, flangeless 1/4"	1
JR-CFL-CB4KF-S	Ferrule, CTFE, 1/4"	1
JR-CFL-2W-S	Nut, PP, flangeless 1/8", white	1
JR-CFL-CB2KF-S	Ferrule, CTFE, 1/8"	1

### SPECS

#### Materials

Union: PEEK  
Nuts: PP, polyacetal  
Ferrules: CTFE

#### Dimensions

See illustrations

#### Threads

reducing Union:  
1/2"-20 to 1/4"-28

#### Pressure rating

1/8" up to 35 bar (500 psi)  
Varies with tubing material and ID

#### Note

The reducing Union is supplied with PP and polyacetal flangeless nuts and ferrules (CTFE) for 1/8" and 1/4" OD tubing

#### Tech Tip

VICI Unions have 1/4"-28 flat bottom ports

All of our three different sealing options (collapsible ferrule, inverted ferrule or flanged with washer) can be used (see pages 59-64)

To avoid diffusion of gases in your solvent line use our Impermeable tubing on page 27

**SPECS**

**Materials**

Unions: PEEK  
Nuts: PPS  
Ferrules: ETFE  
Sleeves: polypropylene

**Dimensions**

See illustration

**Threads**

Unions: 1/4"-28

**Pressure rating**

1/16" up to 105 bar (1500 psi)  
1/8" up to 35 bar (500 psi)  
Varies with tubing material and ID

**Note**

0.75 mm bore version is supplied with PPS flangeless fittings and ETFE ferrules for 1/16" OD tubing (see page 60)

1.50 mm bore version is supplied with PPS flangeless fittings and ETFE ferrules for 1/8" OD tubing (see page 60)

**Tech Tip**

Bulkhead Unions require a min. 10 mm panel hole

**Bulkhead Unions**

- Panel mounting
- For easy connection of low pressure solvent lines
- Low dead volume
- Completely inert and biocompatible

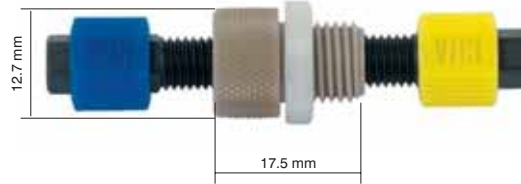

**Bulkhead Unions**

Part No.	Description
JR-CBUMPK	Bulkhead Union, PEEK, LP 0.75 mm bore, complete
JR-CBULPK	Bulkhead Union, PEEK, LP 1.50 mm bore, complete

**Spare Parts**

Part No.	Description	Qty/pkg
JR-55070-10	Nut, PPS, flangeless 1/16"	10
JR-55071-10	Nut, PPS, flangeless 1/8"	10
JR-041-10	Ferrule, ETFE, 1/16"	10
JR-051-10	Ferrule, ETFE, 1/8"	10
JR-55086-10	Adapter, PP, fingertight sleeve, yellow	10
JR-55090-10	Adapter, PP, fingertight sleeve, blue	10

Adapters available in different colors (see page 61)

## PEEK Tees, Crosses and Manifolds Low Pressure

### PEEK Tees, Crosses and Manifolds Low Pressure

- Biocompatible
- Different bore sizes available
- For 1/16" and 1/8" OD tubing
- 1/4"-28 ports

VICI Tees, Crosses and Manifolds for low pressure applications are machined from PEEK. The bodies have 1/4"-28 female ports which accept any flanged or flangeless fitting for 1/8" or 1/16" OD tubing. Choose 0.80 mm and smaller thru-holes

for applications where low flow rate or low dead volume is required. Tees, Crosses and Manifolds with 1.50 mm thru-holes are preferred for high-flow rate applications.



#### PEEK Tees

Part No.	Description
JR-6029	Tee, PEEK, LP bore 0.50 mm, complete
JR-6030	Tee, PEEK, LP bore 0.80 mm, complete
JR-6031	Tee, PEEK, LP bore 1.50 mm, complete

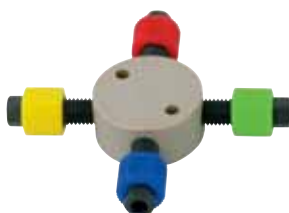

#### PEEK Crosses

Part No.	Description
JR-6039	Cross, PEEK, LP bore 0.50 mm, complete
JR-6040	Cross, PEEK, LP bore 0.80 mm, complete
JR-6041	Cross, PEEK, LP bore 1.50 mm, complete

#### SPECS

##### Material

Body: PEEK  
Fittings: PPS  
Ferrules: ETFE  
Sleeves: Polypropylene

##### Dimensions

Tees and Crosses  
Diameter (body): 25.0 mm  
Thickness (body): 17.1 mm

Manifolds 5 ports  
Diameter (body): 22.2 mm  
Thickness (body): 17.1 mm

Manifolds 9 ports  
Diameter (body): 22.2 mm  
Thickness (body): 28.6 mm

##### Threads

1/4"-28

##### Pressure Rating

1/16" up to 105 bar (1500 psi)  
1/8" up to 35 bar (500 psi)  
Varies with tubing material and ID

##### Note

Complete versions with 0.50, 0.75 and 0.80 mm bore are supplied with PPS flangeless nuts and ETFE ferrules for 1/16" OD tubing (see page 60)

Complete versions with 1.50 mm bore are supplied with PPS flangeless nuts and ETFE ferrules for 1/8" OD tubing (see page 60)

##### Tech Tip

VICI PEEK Tees, Crosses & Manifolds have 1/4"-28 flat bottom ports

All of our three different sealing options (collapsible ferrule, inverted ferrule or flanged with washer) can be used (see pages 59-64)

To avoid diffusion of gases in your solvent line use our Impermeable tubing on page 27

PEEK Tees, Crosses and Manifolds Low Pressure

**SPECS**

**Material**

Body: PEEK  
 Fittings: PPS  
 Ferrules: ETFE  
 Sleeves: Polypropylene

**Dimensions**

Tees and Crosses  
 Diameter (body): 25.0 mm  
 Thickness (body): 17.1 mm

Manifolds 5 ports

Diameter (body): 22.2 mm  
 Thickness (body): 17.1 mm

Manifolds 9 ports

Diameter (body): 22.2 mm  
 Thickness (body): 28.6 mm

**Threads**

1/4"-28

**Pressure Rating**

1/16" up to 105 bar  
 (1500 psi)  
 1/8" up to 35 bar (500 psi)  
 Varies with tubing material  
 and ID

**Note**

Complete versions with 0.50, 0.75 and 0.80 mm bore are supplied with PPS flangeless nuts and ETFE ferrules for 1/16" OD tubing (see page 60)

Complete versions with 1.50 mm bore are supplied with PPS flangeless nuts and ETFE ferrules for 1/8" OD tubing (see page 60)

**Tech Tip**

VICI PEEK Tees, Crosses & Manifolds have 1/4"-28 flat bottom ports

All of our three different sealing options (collapsible ferrule, inverted ferrule or flanged with washer) can be used (see pages 59–64)

To avoid diffusion of gases in your solvent line use our Impermeable tubing on page 27



**PEEK Manifolds**

Part No.	Description
JR-C5M1PK	Manifold, PEEK, 5 ports LP 0.75 mm, complete
JR-C5M2PK	Manifold, PEEK, 5 ports LP 1.50 mm, complete
JR-C9M1PK	Manifold, PEEK, 9 ports LP 0.75 mm, complete
JR-C9M2PK	Manifold, PEEK, 9 ports LP 1.50 mm, complete

**Spare Parts**

Part No.	Description	Qty/pkg
JR-6034	Tee, PEEK, LP bore 0.50 mm, body only	1
JR-6032	Tee, PEEK, LP bore 0.80 mm, body only	1
JR-6033	Tee, PEEK, LP bore 1.50 mm, body only	1
JR-6044	Cross, PEEK, LP bore 0.50 mm, body only	1
JR-6042	Cross, PEEK, LP bore 0.80 mm, body only	1
JR-6043	Cross, PEEK, LP bore 1.50 mm, body only	1
JR-B-C5M1PK	Manifold, PEEK, 5 ports LP 0.75 mm, body only	1
JR-B-C5M2PK	Manifold, PEEK, 5 ports LP 1.50 mm, body only	1
JR-B-C9M1PK	Manifold, PEEK, 9 ports LP 0.75 mm, body only	1
JR-B-C9M2PK	Manifold, PEEK, 9 ports LP 1.50 mm, body only	1
JR-55070-10	Nut, PPS, flangeless 1/16", 1/4"-28	10
JR-55071-10	Nut, PPS, flangeless 1/8", 1/4"-28	10
JR-041-10	Ferrule, ETFE, 1/16"	10
JR-051-10	Ferrule, ETFE, 1/8"	10

Color-Sleeves – fingertight adapters: see page 61.

## PEEK Biocompatible Mixing Tees – Low Pressure

### PEEK Biocompatible Mixing Tees – Low Pressure

- For low pressure mixing
- Completely biocompatible
- Mountable

A unique mixing is the result of the turbulence generated by the introduction angle of the solvents, the streams mix more thoroughly than with a conventional tee.



### PEEK Biocompatible Mixing Tees – Low Pressure

Part No.	Description
JR-CM1XPK	Mixing Tee, PEEK, 0.75 mm bore, complete
JR-CM2XPK	Mixing Tee, PEEK, 1.50 mm bore, complete

### Spare Parts

Part No.	Description	Qty/pkg
JR-B-CM1XPK	Mixing Tee, PEEK, LP bore 0.75 mm, body only	1
JR-B-CM2XPK	Mixing Tee, PEEK, LP bore 1.50 mm, body only	1
JR-55070-10	Nut, PPS, flangeless 1/16", 1/4"-28	10
JR-55071-10	Nut, PPS, flangeless 1/8", 1/4"-28	10
JR-041-10	Ferrule, ETFE, 1/16"	10
JR-051-10	Ferrule, ETFE, 1/8"	10

Color-Sleeves – fingertight adapters: see page 61.

### SPECS

**Material**  
 Body: PEEK  
 Fittings: PPS  
 Ferrules: ETFE

**Dimensions**  
 See illustrations

**Threads**  
 1/4"-28

**Pressure rating**  
 1/16" up to 105 bar (1500 psi)  
 1/8" up to 35 bar (500 psi)  
 Varies with tubing material and ID

**Note**  
 0.75 bore version is supplied with PPS flangeless fittings and ferrules for 1/16" OD tubing (see page 60)

1.50 mm bore version is supplied with PPS flangeless fittings and ferrules for 1/8" OD tubing (see page 60)

**SPECS**

**Material**

Wetted parts: PEEK, PTFE  
 Body: PEEK  
 Fittings: PPS  
 Ferrule: ETFE

**Threads**

1/4"-28

**Dimensions**

Bore: 1.5 mm

**Pressure rating**

200 psi gas<sup>1</sup>  
 500 psi liquid<sup>2</sup>  
 .060" bore

<sup>1</sup>Tested with helium using 1/16" OD x 0.84 mm ID PTFE tubing with PEEK collapsible ferrules

<sup>2</sup>Tested with isopropanol using 1/8" OD x 0.75 mm ID PTFE tubing with CTFE collapsible ferrules

**Note**

Complete versions are supplied with PPS flangeless nuts and CTFE ferrules for 1/8" OD tubing

**Tech Tip**

VICI Jour Micro Valves have 1/4"-28 flat bottom ports

All of our three different sealing options (collapsible ferrule, inverted ferrule or flanged with washer) can be used (see pages 59–64)

To avoid diffusion of gases in your solvent line use our Impermeable tubing on page 27

**Micro Valves for GC and LC**

**NEW**

- Compact 1" design
- Biocompatible and inert
- Convenient panel mount, hole diameter 8 mm (0.3125")

VICI Jour Micro Valves are the ideal tools for flow selection. The valves are mountable and are pre-fitted with the VICI Jour

PPS, flangeless 1/4"-28 fittings and CTFE collapsible ferrules for 1/8" OD tubing.

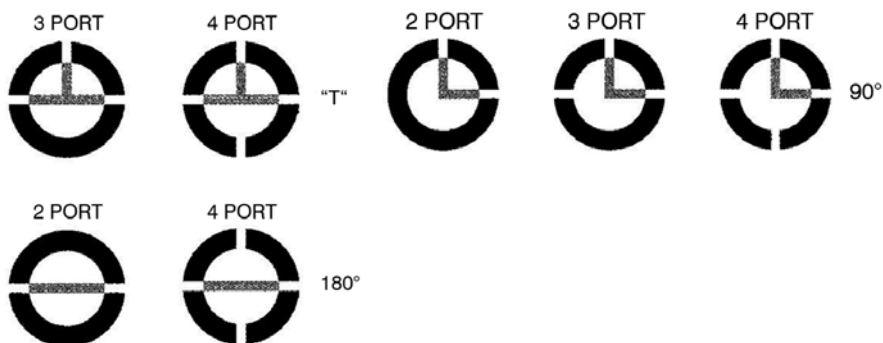

**Micro Valves**

Part No.	Description
JR-660100	Valve, 3-port, manual, "T-flow", complete
JR-660110	Valve, 4-port, manual, "T-flow", complete
JR-660200	Valve, 2-port, manual, "180°", complete
JR-660210	Valve, 4-port, manual, "180°", complete
JR-660300	Valve, 2-port, manual, "90°", complete
JR-660310	Valve, 3-port, manual, "90°", complete
JR-660320	Valve, 4-port, manual, "90°", complete

**Spare Parts**

Part No.	Description	Qty/pkg
JR-55071-10	Nut, PPS, flangeless 1/8", 1/4"-28	10
JR-CFL-CB2KF	Ferrule, CTFE, collapsible, 1/8"	10
JR-55050-10	Nut, PPS, for collapsible ferrule, 1/16", 1/4"-28	10
JR-CFL-CB1PK	Ferrule, PEEK, collapsible, 1/16"	10

Color-Sleeves – fingertight adapters: see page 61.

## Peristaltic Tubing Adapter Set

### Peristaltic Tubing Adapter Set

- For connecting soft tubing to PTFE & PTFE like tubing
- Works with peristaltic tubing up to 4.50 mm OD
- For 1/16" and 1/8" PTFE & PTFE like tubing
- Biocompatible
- Low dead volume

The "One-Fits-All" set consists of everything to connect 1/16" or 1/8" OD PTFE & PTFE like tubing to soft tubing like silicone up to 4.50 mm OD. The adapter

comes with three different bushings (for the different soft tubing ODs) and two fittings/ferrules (one each for 1/16" and 1/8" OD tubing).



### Peristaltic Tubing Adapter Set

Part No.	Description
JR-PTAS	Adapter, PEEK, for Peristaltic to PTFE tubing connections, complete

### Specs

#### Material

Body and Bushings: PEEK  
Fittings: PPS  
Ferrules: ETFE

#### Dimensions

Bore: 0.50 mm  
Length: 28 mm  
(without fitting)  
Diameter: 12 mm

#### Threads

Barbed to 1/4"-28

#### Tech Tip

The set is equipped with fittings and ferrules for inverted ferrule connections. The adapter also works with our other sealing options (see page 59–60)











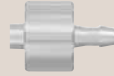

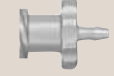



Low-Pressure Polypropylene Adapters

SPECS

Material  
Polypropylene

Low-Pressure Polypropylene Adapters

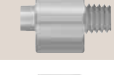
Low-Pressures Polypropylene Adapters

Part No.	Description		Qty/pkg
JR-070211-10	Adapter, PP, male Luer to 1/16" barbed		10
JR-070212-10	Adapter, PP, male Luer to 3/32" barbed		10
JR-070213-10	Adapter, PP, male Luer to 1/8" barbed		10
JR-070111-10	Adapter, PP, female Luer to 1/16" barbed		10
JR-070112-10	Adapter, PP, female Luer to 3/32" barbed		10
JR-070113-10	Adapter, PP, female Luer to 1/8" barbed		10
JR-070101-10	Adapter, PP, female to female Luer		10
JR-070124-10	Adapter, PP, female Luer to 10-32 male		10
JR-070123-10	Adapter, PP, female Luer to 1/4"-28 male		10
JR-071123-10	Adapter, PP, 1/4"-28 male to 1/16" barbed		10
JR-071323-10	Adapter, PP, 1/4"-28 male to 1/8" barbed		10
JR-072350-10	Adapter, PP, plug 1/4" -28 male		10
JR-071124-10	Adapter, PP, 10-32 male to 1/16" barbed		10
JR-071324-10	Adapter, PP, 10-32 male to 1/8" barbed		10
JR-072450-10	Adapter, PP, plug 10-32 male		10
JR-070224-10	Adapter, PP, male Luer to 10-32 male		10
JR-070225-10	Adapter, PP, male Luer to 1/4"-28 female		10